

PKG-232-MBC25-PS-CBL

System Diagram and Specifications

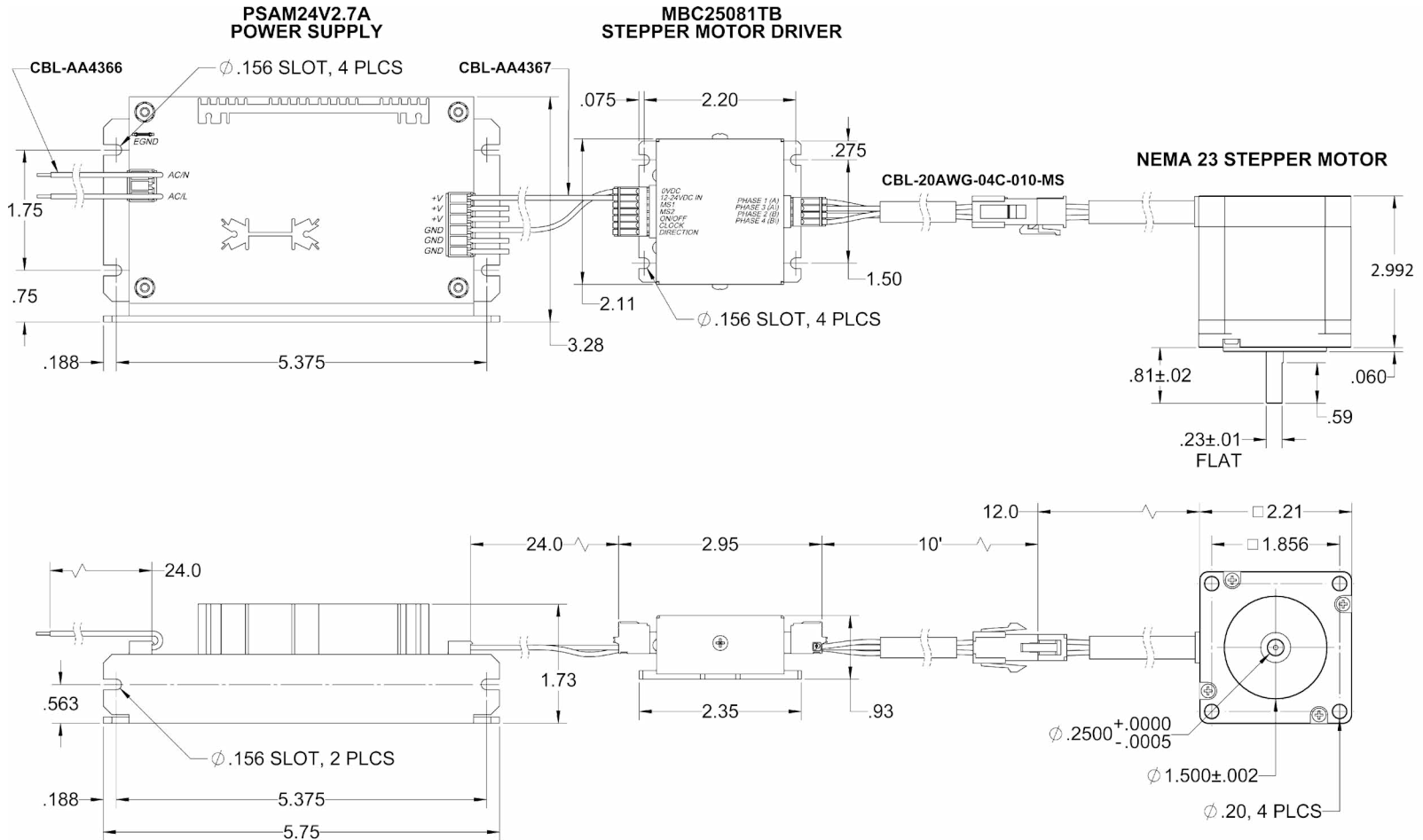

*All units are inches

Included Components:

23Y206S-LW8-MS	Stepper Motor
MBC25081TB	Stepper Driver
PSAM24V2.7A	Power Supply
CBL-20AWG-04C-010-MS	Motor Cable
CBL-AA4366	Power Supply IN
CBL-AA4367	Power Supply OUT

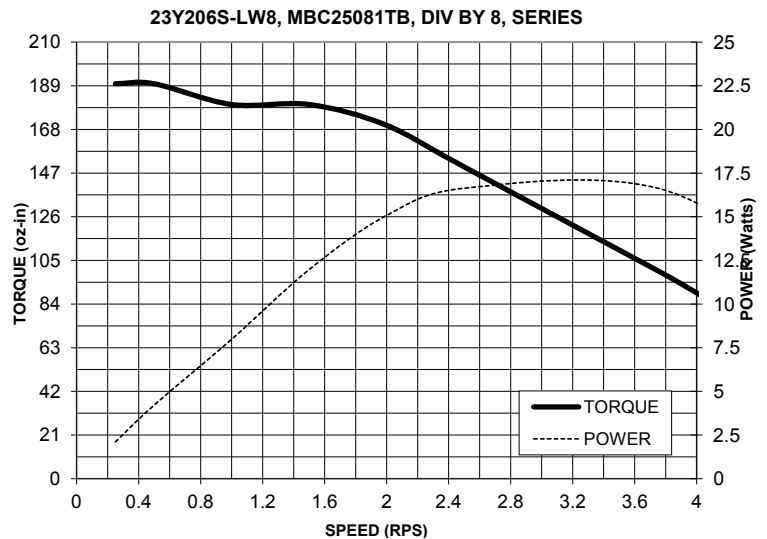

L010864

23Y206S-LW8-MS - High Torque Stepper Motor

FEATURES

- **NEMA 23 Frame Size**
- **Holding Torque - 262 oz-in**
- **1.8° Step Angle**
- **High Step Accuracy and Resolution**
- **Low Vibration and Noise**
- **CE Certified RoHS Compliant**

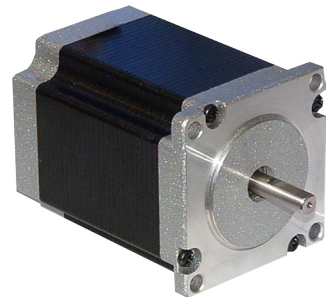

The 23Y206S-LW8-MS High Torque Stepper Motor offers a great value without sacrificing quality. This motor was designed to offer the highest possible torque while minimizing vibration and audible noise. It is wired in series with a Molex 4 pin Mini-Fit Jr. receptacle.

A 10 ft. 4 conductor, 20 AWG cable with mating 4 pin Mini-Fit Jr. plug is included in the PKG-232-MBC25-PS-CBL stepper motor/driver package.

SPECIFICATIONS

Model #	NEMA Size	Holding Torque (oz-in)	Bipolar Current (A)	Bipolar Voltage (V)	Bipolar Resistance (ohms)	Bipolar Inductance (mH)	Rotor Inertia (oz-in-sec ²)	Shaft Diameter (in)	Weight (lbs)	Length (in)
23Y206S-LW8-MS	23	262	2.1	4.2	2.0	1.6	0.0068	0.25	2.21	2.992

Step Angle Accuracy:	± 5% (Full Step, No Load)	Insulation Resistance:	100M Ohm Min, 500VDC
Resistance Accuracy:	± 10%	Dielectric Strength:	500VDC for 1 minute
Inductance Accuracy:	± 20%	Shaft Radial Play:	0.02" Max (1.0 lbs)
Temperature Rise:	80°C Max (2 Phases On)	End Play:	0.08" Max (1.0 lbs)
Ambient Temperature:	-20° to +50° C	Max Radial Force:	16.3 lbs
Insulation Type:	Class B	Max Axial Force:	2.2 lbs-Force

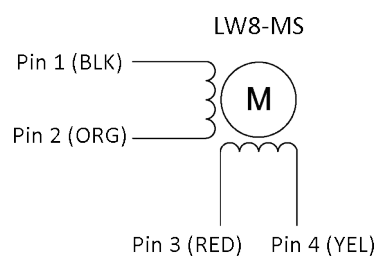

Pin #	Lead Wire Connection	Lead Wire Color
1	Phase 1 (A)	Black
2	Phase 3 (A)	Orange
3	Phase 2 (B)	Red
4	Phase 4 (B)	Yellow
	Soldered Together	White/Black & White/Orange
	Soldered Together	White/Red & White/Yellow

MBC25081TB - Microstep Driver



FEATURES

- **Compact Microstep Driver**
- **Detachable Terminal Blocks**
- **0.5 - 2.5 Amp Output Current**
- **24VDC Compatible Input Signals**
- **Sinking and Sourcing Inputs**
- **12-24VDC Operating Voltage**
- **Low Cost - Excellent Value**
- **Easy to Install**



DESCRIPTION

The MBC25081TB is a miniature, fully enclosed stepper motor driver perfect for applications where space is limited. With a footprint less than 2.5" square, this microstepping driver provides great performance and flexibility for a driver its size. The MBC25081TB's greatest asset is how easy it is to use. The detachable spring loaded terminal blocks make it simple to install and eliminates the additional connector and cable accessories commonly associated with other compact stepper drivers. You won't need extra "tools" to wire the MBC25081TB.

The MBC25081TB is a bipolar type microstepping driver which can deliver anywhere from 0.5 - 2.5 Amps output current (selectable with a small potentiometer on the side). The driver operates from 12VDC minimum to 24VDC maximum voltage and the inputs are capable of running from either open collector or TTL level logic outputs, or sourcing 24VDC outputs from PLCs, microcontrollers, or any device that outputs step and direction signals.

The driver features microstep resolutions of 200, 400, 800, and 1600 steps/revolution, providing smooth rotary operation. Other features include built in over temperature and short circuit shutdown, automatic current reduction at standstill, and LED's to indicate power on and clock pulses being received. If you lack space but expect performance, the MBC25081TB is the driver for a great option.

SPECIFICATIONS

Power Requirements:	12 - 24 VDC	Minimum Input Current:	0.5 mA
Output Current Range:	0.5 - 2.5 Amps (Peak)	Input Signal Voltage:	3.5-24 VDC
Microstepping Resolution:	200, 400, 800 and 1600 Steps/Revolution	Storage Temperature:	0°-50°C
Input Clock Frequency:	0 - 500 kHz	Absolute Maximum Driver Temperature:	70°C

Control Inputs (Pins 1, 2, 3, 4, 5):

MICROSTEP RESOLUTION TRUTH TABLE		
Desired Resolution	MS1 Setting	MS2 Setting
Full Step	Active	Active
Half Step	Inactive (Open)	Active
Quarter Step	Active	Inactive (Open)
Eighth Step	Inactive (Open)	Inactive (Open)

Direction: Logic "1" CW
Logic "0" CCW

Clock: Active - 1 Step
Inactive (open) - Reduce Current Mode

On/Off: Active - Off
Inactive (open) - On

Notes: Open Inputs are inactive and internally pulled up to +5VDC for JP1 position 1-2 (Sinking)
Open Inputs are inactive and internally pulled down to 0VDC for JP1 position 2-3 (Sourcing)

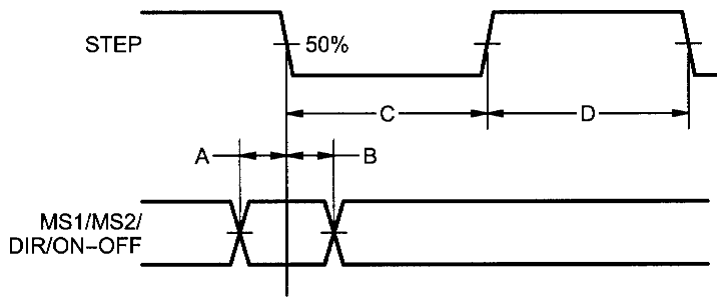

- A. Minimum Command Active Time Before Clock Pulse (Data Set-Up Time) ... 200nS
- B. Minimum Command Active Time After Clock Pulse (Data Hold Time) 200nS
- C. Minimum CLOCK Pulse Width 1.0uS
- D. Minimum CLOCK Inactive Time 1.0uS
- Maximum CLOCK Frequency 500kHz

Connecting the Stepper Motor

Phase 1 and Phase 3 of the stepper motor are connected to pins 1 and 2 on connector P2. Phase 2 and Phase 4 of the step motor are connected to pins 3 and 4 on connector P2. Please refer to the figure for a TYPICAL APPLICATION HOOK-UP.

Note: The physical direction of the motor with respect to the direction input will depend on the connection of the motor windings. To reverse the direction of the motor with respect to the direction input, switch the wires on Phase 1 and Phase 3.

TYPICAL APPLICATION HOOK-UP

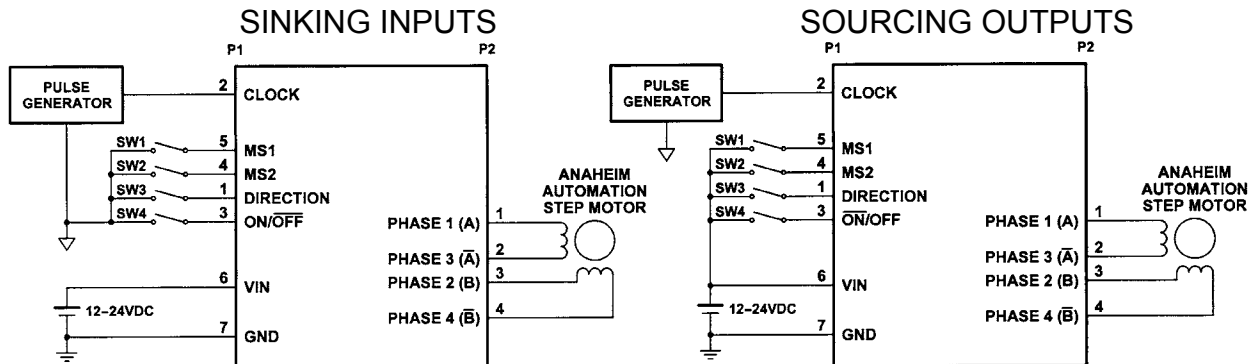

With JP1 in position 1-2 (sinking) the inputs are considered inactive or Logic "1" if left open, or active or Logic "0" if grounded. With JP1 in position 2-3 (sourcing) the inputs are considered inactive or Logic "0" if left open, and active or Logic "1" if pulled to 3.5 - 24VDC.

WARNING: DO NOT CONNECT OR DISCONNECT MOTOR WIRES WHILE POWER IS APPLIED!

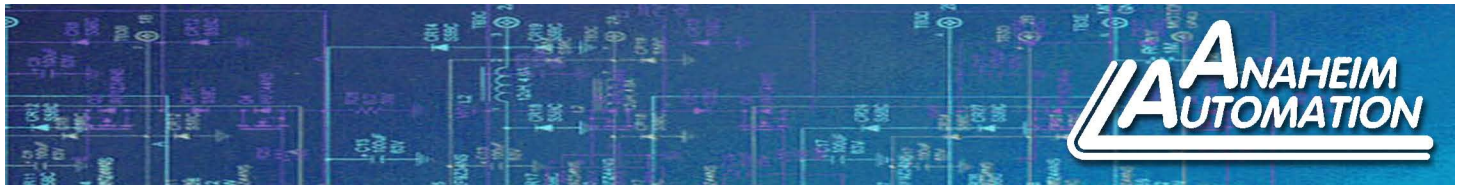

Setting the Output Current

In the MBC25081TB, a sine/cosine output function is used in rotating the motor. The output current for a given motor is determined by the motors current rating and the wiring configuration of the motor. There is a current adjustment potentiometer used to set the output current of the MBC25081TB. This sets the peak output current of the sine/cosine waves.

The specified motor current of 2.1A for the 23Y206S-LW8-MS (which is the bipolar value) is multiplied by a factor of 1.4 to determine the current adjustment potentiometer value of 3.0Amps or 100%.

MBC25081TB Potentiometer Settings			
Peak Current	Potentiometer Setting	Peak Current	Potentiometer Setting
0.50A	0%	1.70A	60%
0.70A	10%	1.90A	70%
0.90A	20%	2.0A	75%
1.10A	30%	2.10A	80%
1.30A	40%	2.30A	90%
1.50A	50%	3.00A	100%

WARNING! Stepper motors will run hot even when configured correctly. Damage may occur to the motor if a higher than specified current is used. Most specified motor currents are maximum values. Care should be taken to not exceed these ratings.

Reducing Output Current

Reducing the output current is accomplished automatically and occurs approximately 20mSec after the last the clock input has been received. The amount of current per phase in the reduction mode is approximately 70% of the set current. When the current reduction circuit is activated, the current reduction resistor is paralleled with the current adjustment potentiometer. This lowers the total resistance value, and thus lowers the per phase output current.

PSAM24V2.7A - Power Supply

FEATURES

- **Low Cost, High Reliability**
- **High Efficiency, Low Working Temperature**
- **Built in EMI Filter, Low Ripple Noise**
- **100% Full Load Burn-In Test**
- **Short Circuit/Over Voltage/Overload Protection**
- **Compact Size**
- **Light Weight**

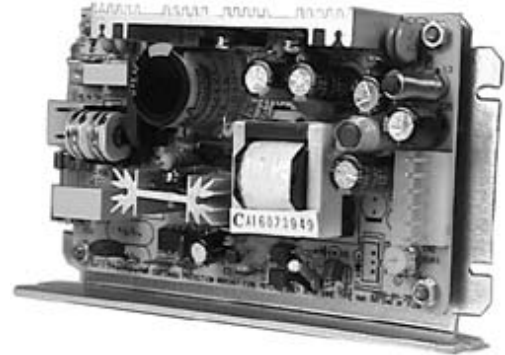

DESCRIPTION

The PSAM24V2.7A power supply has a single voltage output with power capabilities of up to 65 watts. With an adjustable output, these power supplies are efficient to run Anaheim Automation’s line of low current microsteppers and programmable controllers. With a compact size of 5.75” x 3.25” x 1.74” and dual mounting position “L Bracket”, the PSAM24V2.7A can be mounted just about anywhere. The kit includes a 3 pin 24” input power cable and a 6 pin 24” output power cable.

SPECIFICATIONS

DC Voltage Output:	24V	Output Voltage Tolerance:	±2%
Output Rated Current:	2.7A	Ripple & Noise:	100mVp-p
Load Regulation	±2%	Rated Output Power:	65W
Efficiency:	80%	DC Voltage Adjust:	+10, -5% (Use SVR1 to Adjust)
Input Voltage Range:	90-264VAC, 47-440Hz	AC Current:	1A/115V, 0.7A/230V
AC Inrush Current:	Cold Start 20A/115V, 40A/230V	Leakage Current:	<0.5 mA